

SL000140-GX

Pos.	Cod.	Descrizione	Description	Q.ty	Note
1	550370	Curva ø 25	Elbow	1	
2	550242	Girello 1" G	Ring nut	1	
3	550350	OR ø 23,81x2,62	O-Ring	2	
4	1040780	Nipples 1" G (M)-(M)	Threaded adapter	1	
5	550040	OR ø 26,65x2,62	O-Ring	1	☒
6	1040670	Distanziale	Spacer	1	
8	1040660	Sede inox	Inox seat	1	
9	130491	Rub. 3/8"-1/2" G (M) DX	Right valve	3	ex 30491 ⚡
10	1040690	Forcella	Fork	2	
11	550545	Manometro ø 63	Pressure gauge	1	0-80 bar ⚡
12	1040680	Corpo principale 3 vie	3-way main body	1	
13	390180	OR ø 18,72x2,62	O-Ring	6	☒
14	130171	Tappo 3/8" G	Plug	2	ex 30171 ⚡
15	1040820	Spina elastica	Pin	1	
16	180030	Vite TCEI M 8x20	Bolt	4	C ₂₀
17	1040720	Corpo distributore	Valve body	1	
18	1040730	Maniglia	Knob	1	
19	1080200	OR ø 5,6x2,2	O-Ring	1	▶
20	1040700	Perno selettore	Selector pin	1	☒
21	850680	Molla chiusura	Spring	1	⊕
22	850660	Sfera	Ball	1	
23	850650	Sede mandata	Seat	2	☒
24	740290	OR ø 14x1,78	O-Ring	2	▶
25	1040710	OR ø 56x2	O-Ring	1	▶
26	1040600	Corpo principale	Main body	1	
27	680560	Vite TCEI M 6x16	Bolt	1	⚡ C ₁₀
28	1040650	Molla	Spring	1	⊕
29	1040640	Valvola inox	Valve	1	
30	1040630	Membranina	Diaphragm	1	Desmopan
31	1040631	Membranina	Diaphragm	1	Gomma
32	880833	OR ø 15,54x2,62	O-Ring	1	▶
34	1040622	Pistone	Piston	1	☒
35	1040830	Molla	Spring	1	⊕
36	394770	Perno compr. molla	Spring pin	1	☒
37	1040610	Corpo guida molla	Spring guide body	1	
38	550331	Rosetta øi 6,5	Washer	4	
39	1040370	Vite TCEI M 6x22	Bolt	4	C ₁₀
40	394790	Manopola regolazione	Adjustment knob	1	
43	480550	Anello seeger	Circlip	1	
43	1040760	Attacco 3/4" G	Coupling	1	

Pos.	Cod.	Descrizione	Description	Q.ty	Note
45	1040810	Portagomma ø 13x24	Hose tail	2	
45	850780	Portagomma ø 19x34	Hose tail	2	
46	1040790	Girello raccordo 3/4" G	Nut	2	Per/For ø 13
46	850790	Girello raccordo 3/4" G	Nut	2	Per/For ø 19
47	1040800	Ghiera raccordo	Ring nut	2	Per/For ø 13
47	850770	Ghiera raccordo	Ring nut	2	Per/For ø 19
48	1040770	Attacco 3/4" G (M)	Coupling	1	
49	550210	Tubetto ø 25	Hose tail	1	
50	390270	Dado M 8	Nut	2	
51	180370	Vite TE M 8x25	Bolt	2	C ₂₀
52	850690	Staffa	Bracket	1	
53	770130	OR ø 20,35x1,78	O-Ring	1	▶
54	1150650	Vite TCTC M 3x60	Screw	1	⚡ C ₅
55	960160	OR ø 17,86x2,62	O-Ring	2	▶
56	110131	Racc. 1/2" G+tub. ø10	Fitting 1/2" G+hose ø10	2	ex 10131
57	1040950	Copiglia	Split pin	3	
58	880830	OR ø 15,54x2,62	O-Ring	2	▶
59	1150580	Portagomma ø 13	Hose tail	2	
62	110130	Racc. 1/2" G+tub. ø13	Fitting 1/2" G+hose ø13	1	
63	450145	Flangia raccordo	Flange	1	
64	1362	Valvola reg. completa	Compl.reg.valve	1	

○ Non compreso nel VDR 40 - No part of VDR 40
● Compresso nella pompa - Part of pump

KIT 1955 OR - O-Rings		KIT 1956 Pronto intervento N° 1 - Maintenance repair N° 1				KIT 2484 Pr. interv. N° 2 - Mant. rep. N° 2	
Pos.	Q.ty	Pos.	Q.ty	Pos.	Q.ty	Pos.	Q.ty
3	2	3	2	25	1	3	2
5	1	5	1	28	1	5	1
13	4	10	2	29	1	8	1
19	1	13	4	30	1	27	1
24	2	15	1	31	1	29	1
25	1	19	1	39	1	30	1
31	1	21	1	53	1	31	1
53	1	22	1	57	2		
55	2	23	2				
		24	2				

NOTE

SOME PARTS ARE NON-STOCK
ITEMS AND MAY NEED TO BE
ORDERED

VDR 50

NOTE

PLEASE ADD PREFIX **AR**
TO REFLECT CROPLANDS
PART NUMBER

Kit per/for VDR 50

KIT 978 "I"

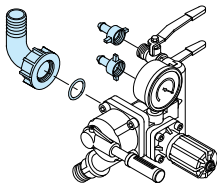

UN000505-GF

KIT 991 "S"

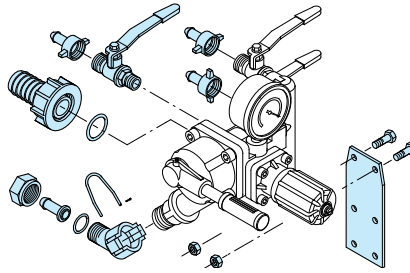

UN000501-GF

KIT 946 "I" - "S"

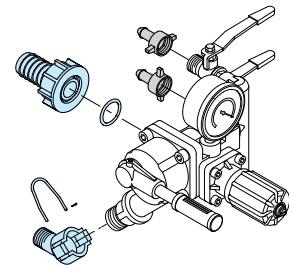

UN000502-GF

KIT 998 "S"

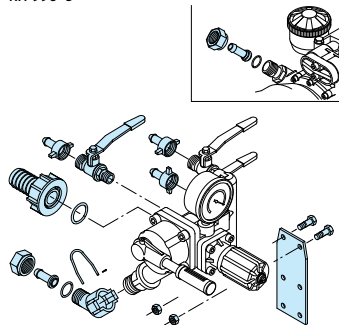

UN000503-GF

KIT 986 "S"

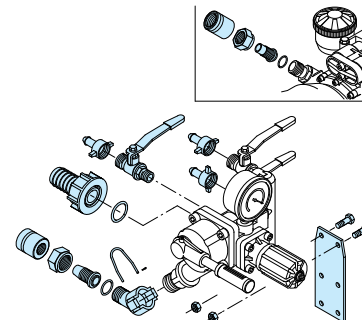

UN000504-GF

KIT 987 "S"

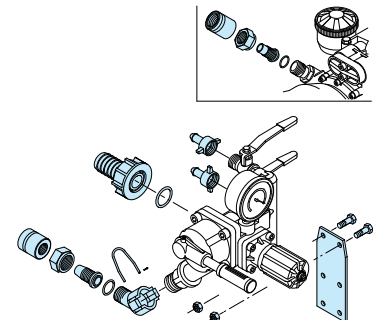

UN000506-GF

Comando incorporato e separato - Build-in control unit and remote control

KIT 978 "I" Comando incorporato Build in control			
Pos.	Q.ty	Pos.	Q.ty
1	1		
2	1		
3	1		
56	2		
Per / for AR 713 - AR 813 - AR 1064			

KIT 991 "S" Comando separato Remote control			
Pos.	Q.ty	Pos.	Q.ty
2	1	56	3
3	1	57	1
9	1	58	1
10	1	59	1
46	1		
48	1		
49	1		
50	2		
51	2		
52	1		
Per / for AR 30 - AR 50			

KIT 946 "S" Comando separato Remote control		KIT 946 "I" Comando incorporato Build in control	
Pos.	Q.ty	Pos.	Q.ty
2	1	2	1
3	1	3	1
10	1	10	1
48	1	48	1
49	1	49	1
57	1	57	1
Per / for AR 503 - AR 713 AR 813 - AR 1064 AR 1265 - AR 903 AR 1053 - AR 1203 BHA/BHS/BHP 130		Per / for AR 903 AR 1053 - AR 1203 BHS 90 - 105 - 120	

KIT 998 "S" Comando separato Remote control			
Pos.	Q.ty	Pos.	Q.ty
2	1	52	1
3	1	56	3
9	1	57	1
10	1	58	2
46	2	59	2
48	1		
49	1		
50	2		
51	2		
Per / for AR 503 - AR 903 - AR 1053 - AR 1203 AR 713 - AR 813 - AR 1064 - AR 1265 BHA/BHS/BHP 130			

KIT 986 "S" Comando separato Remote control			
Pos.	Q.ty	Pos.	Q.ty
2	1	51	2
3	1	52	1
9	1	55	2
10	1	56	3
45	2	57	1
46	2		
47	2		
48	1		
49	1		
50	2		
Per / for AR 503 - AR 713 - AR 813			

KIT 987 "S" Comando separato Remote control			
Pos.	Q.ty	Pos.	Q.ty
2	1	51	2
3	1	52	1
10	1	55	2
45	2	56	2
46	2	57	1
47	2		
48	1		
49	1		
50	2		
Per / for AR 903 - AR 1053 - AR 1203 AR 1064 - AR 1265 BHA/BHS/BHP 130			

Gruppi comando
Control units